

Vårdagjämning befintlig byggnadshöjd (2 våning)

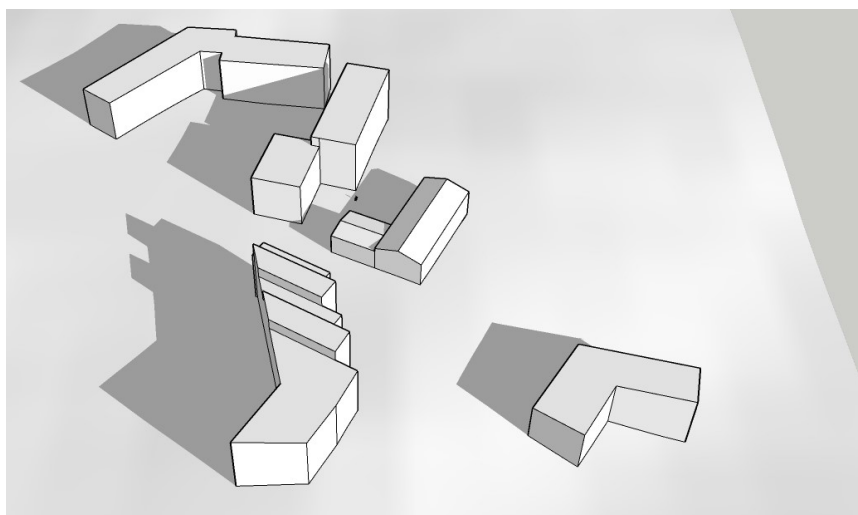

KI 09:00

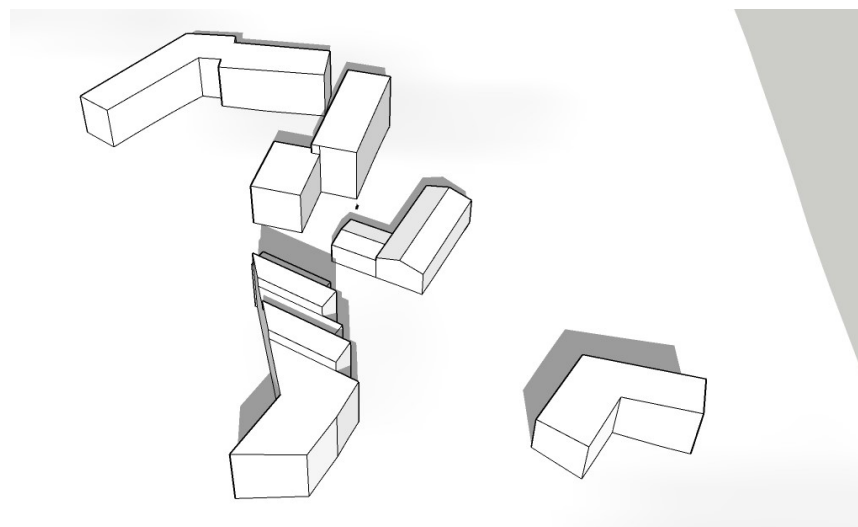

KI 12:00

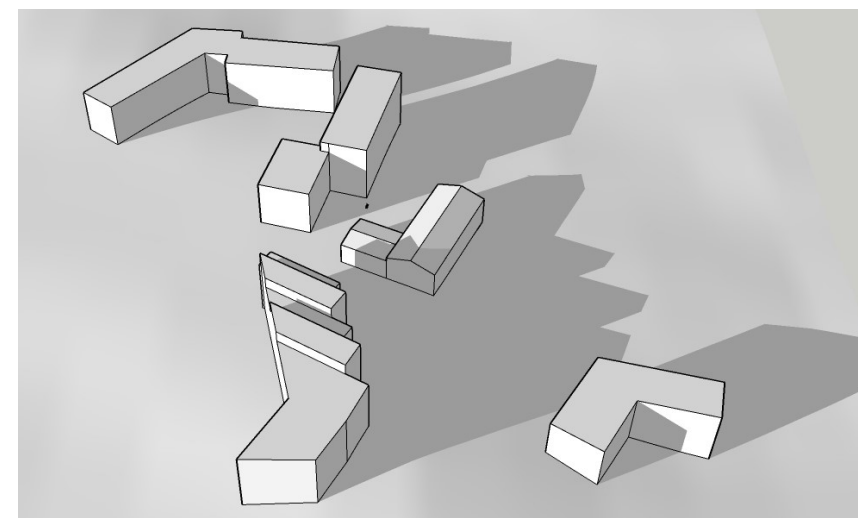

KI 16:00

Vårdagjämning utökad byggnadshöjd (4 våning)

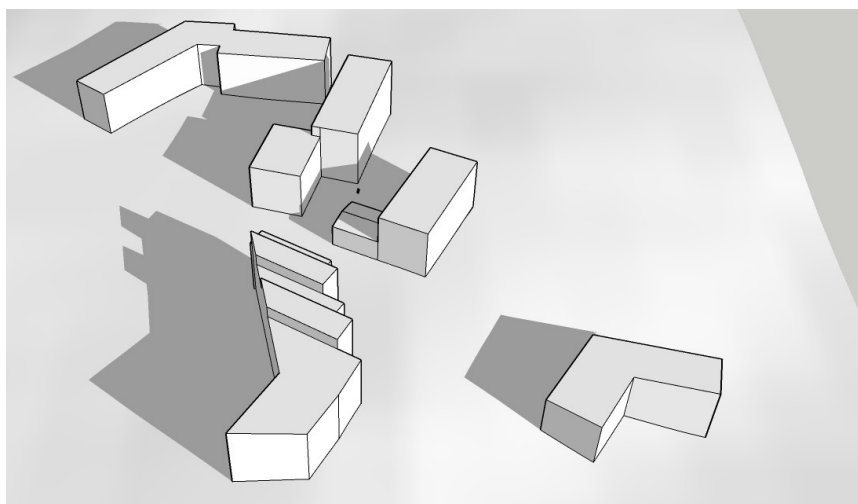

KI 09:00

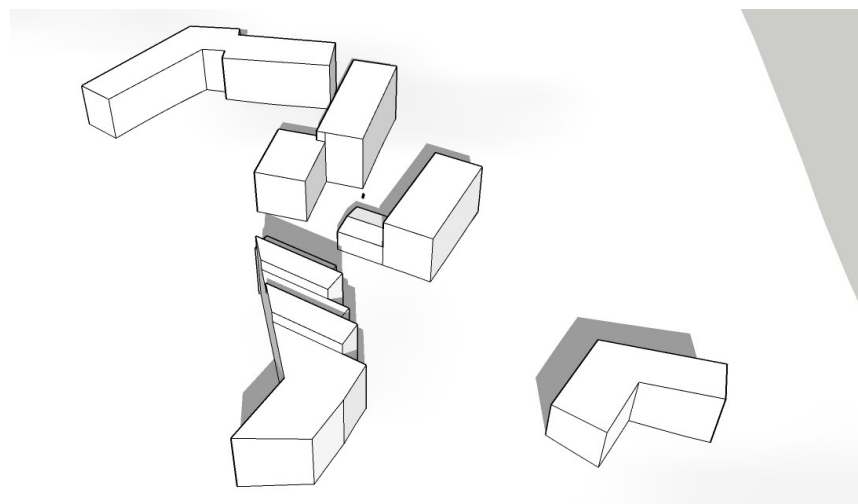

KI 12:00

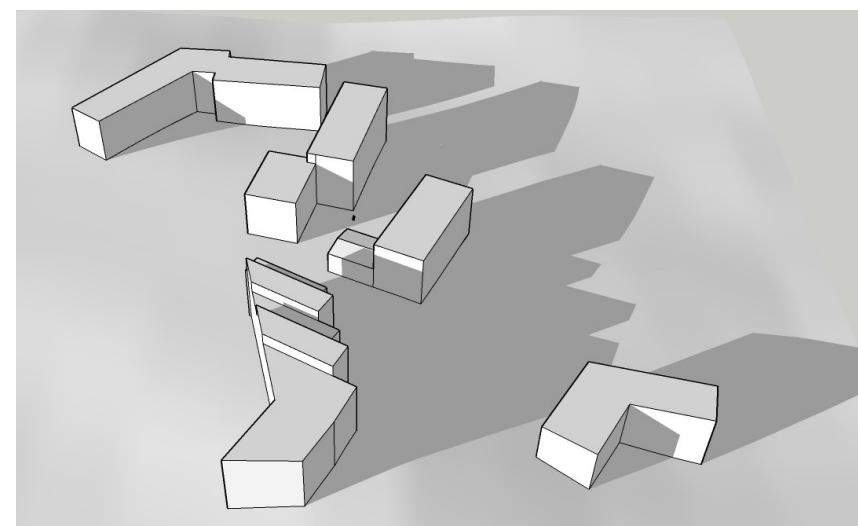

KI 16:00

Sommarsolstånd befintlig byggnadshöjd (2 våning)

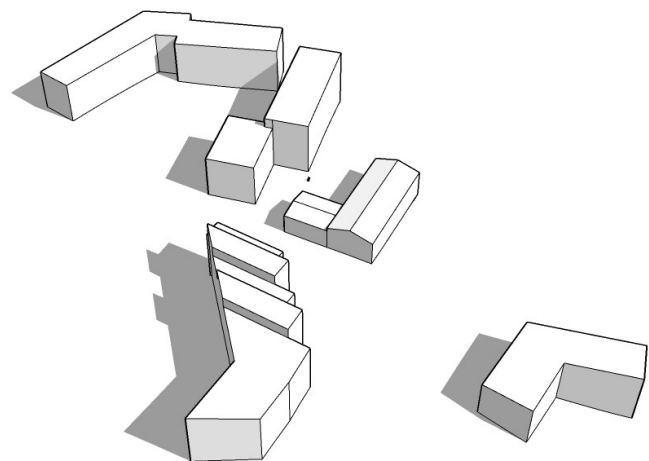

KI 09:00

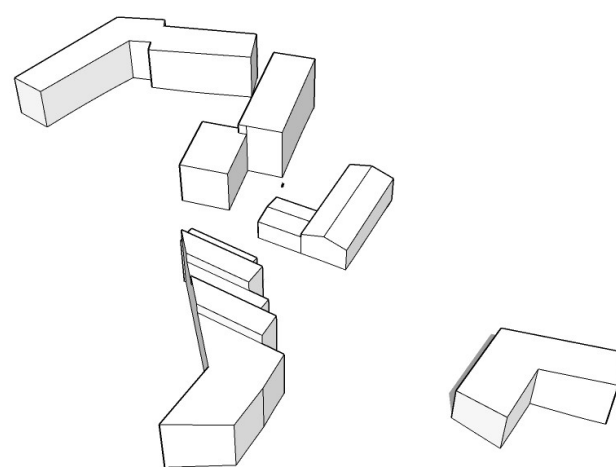

KI 12:00

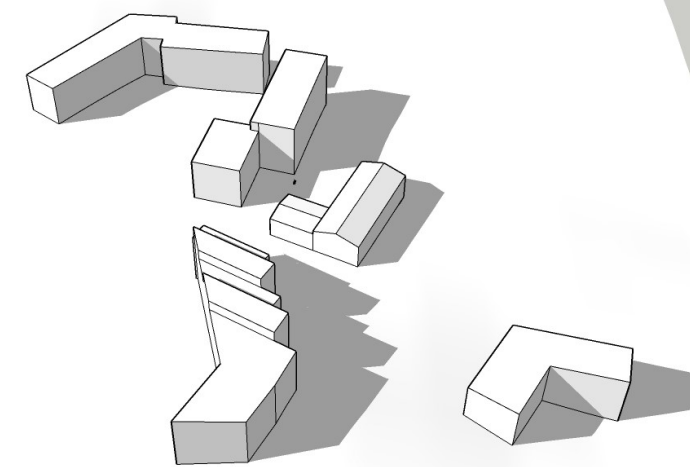

KI 16:00

Sommarsolstånd utökad byggnadshöjd (4 våning)

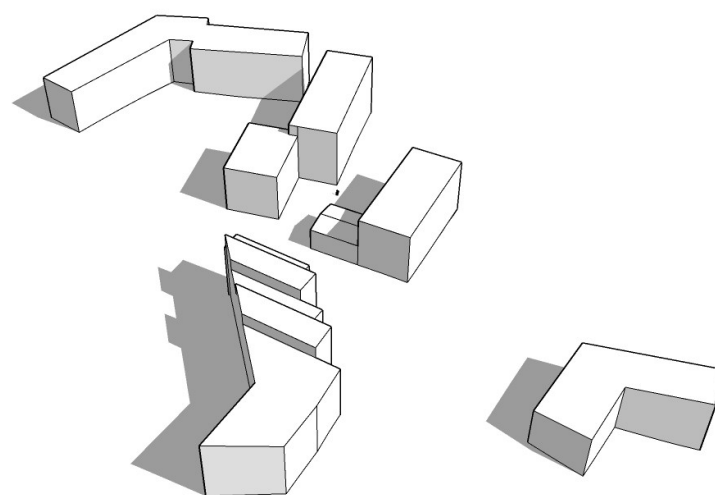

KI 09:00

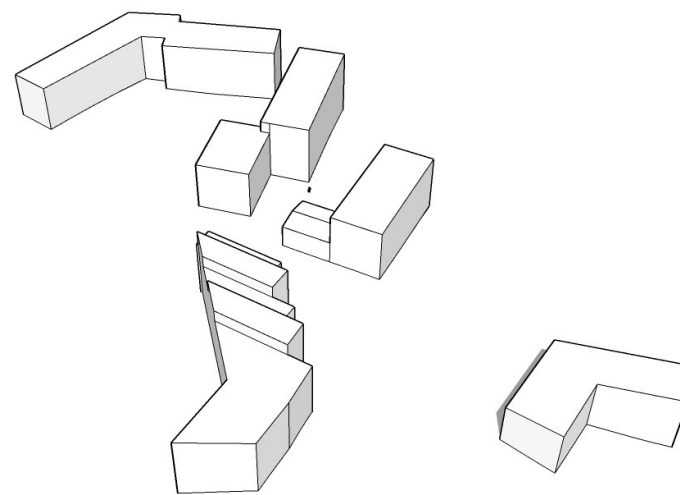

KI 12:00

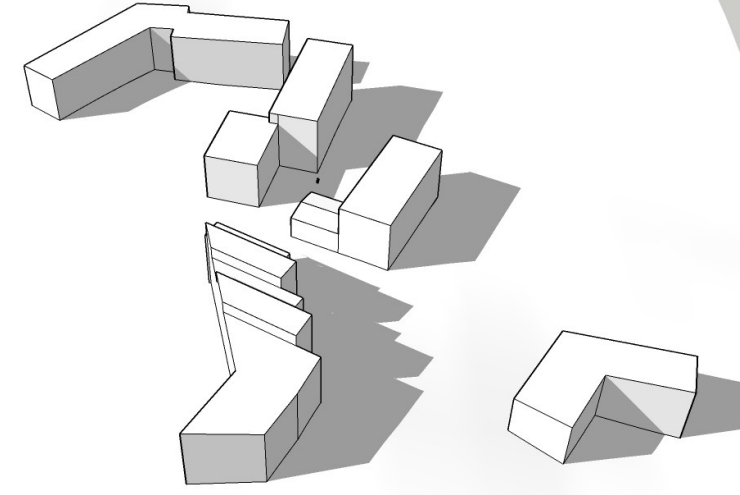

KI 16:00

Höstdagjämning befintlig byggnadshöjd (2 våning)

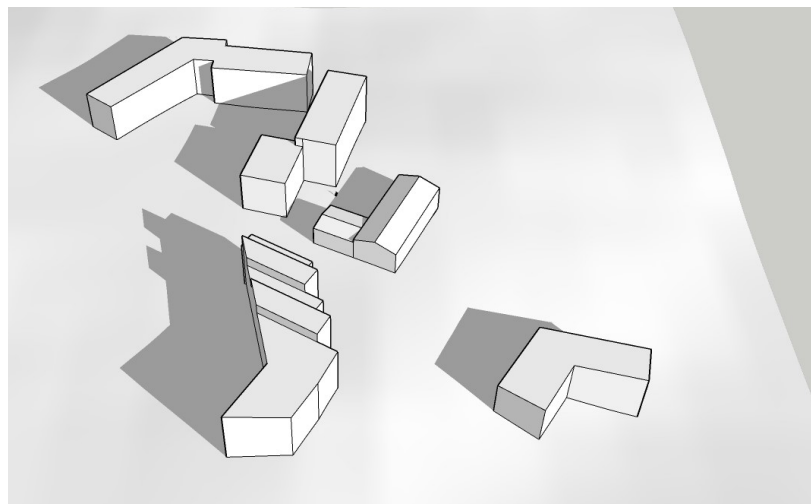

KI 09:00

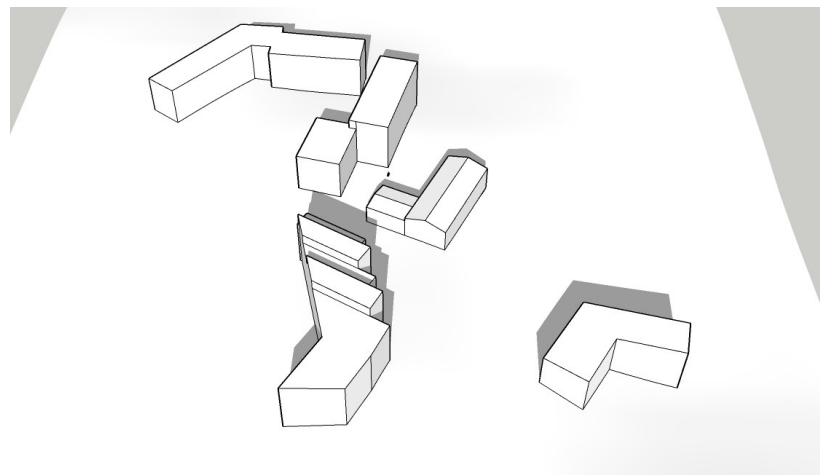

KI 12:00

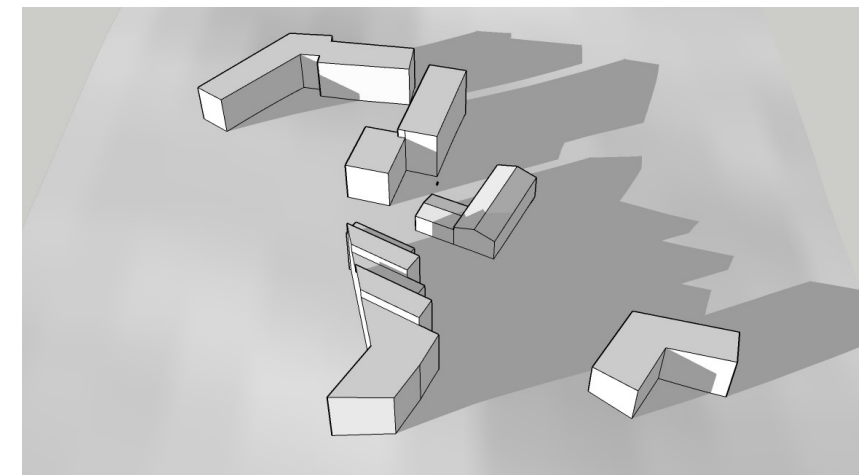

KI 16:00

Höstdagjämning utökad byggnadshöjd (4 våning)

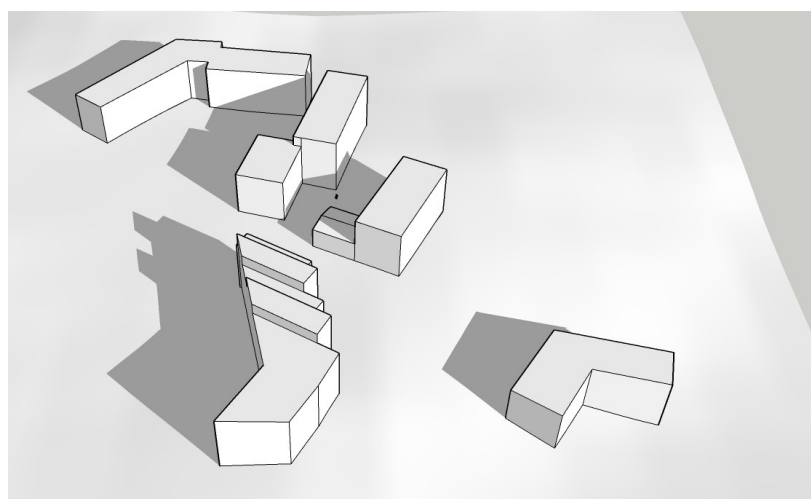

KI 09:00

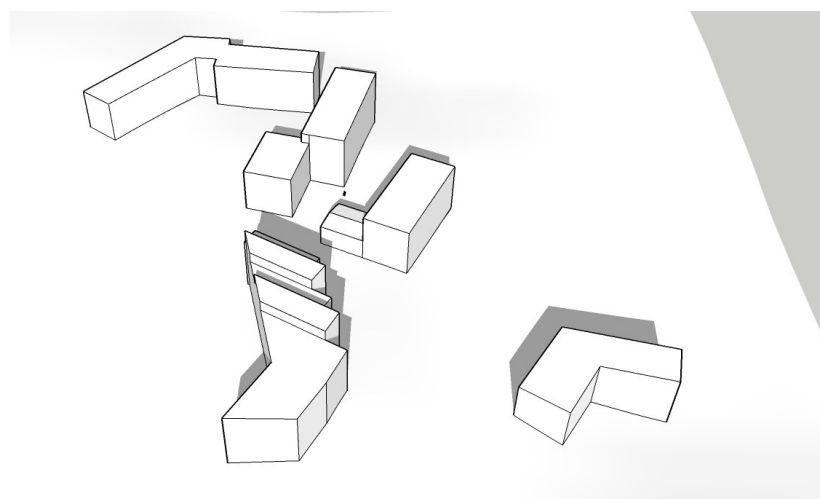

KI 12:00

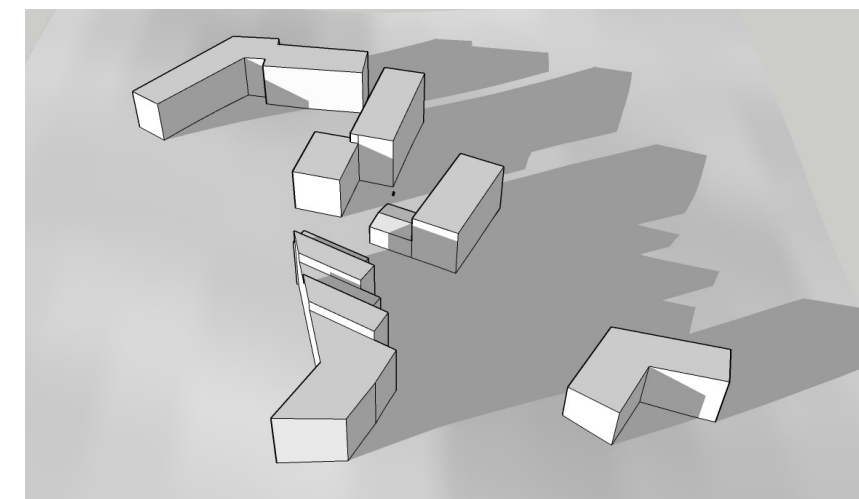

KI 16:00